

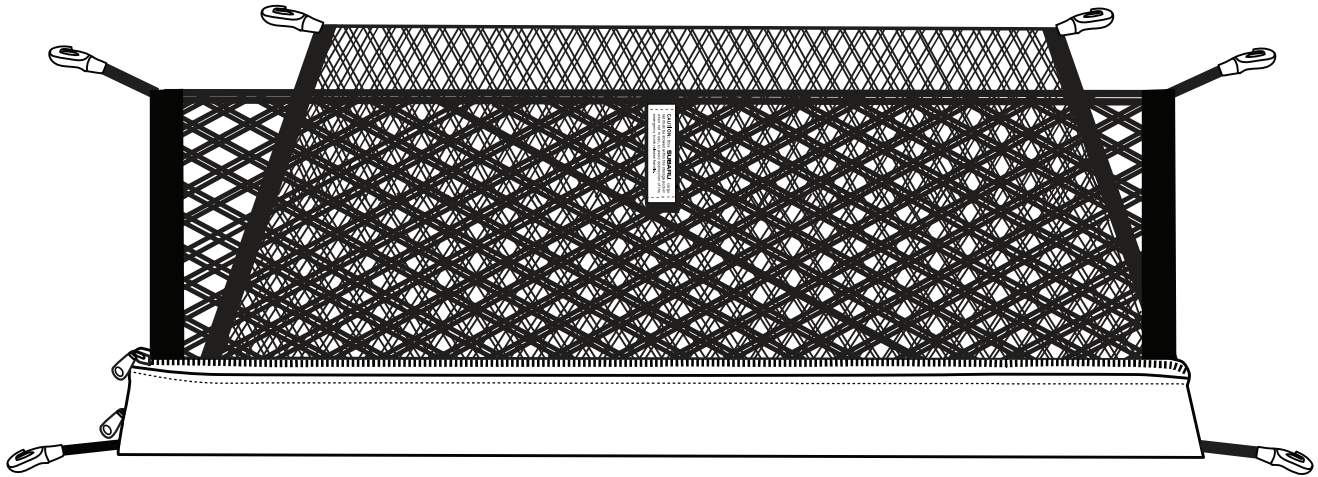











**A KIT CONTENTS:**

**1X**



**TOOLS REQUIRED: NONE**

**Meaning of Characters:**

-  : Remove
-  : Install
-  : Disconnect
-  : Connect
-  : Location of pre-arranged mark
-  : Driver side rear cargo area
-  : Passenger side rear cargo area
- T** : Tightening Torque
-  : Loosen
-  : Discard
-  : Recyclable
-  : View

NOTE: Installation steps shown below are for the drivers side of the vehicle.  
Please follow the same steps for the passengers side.

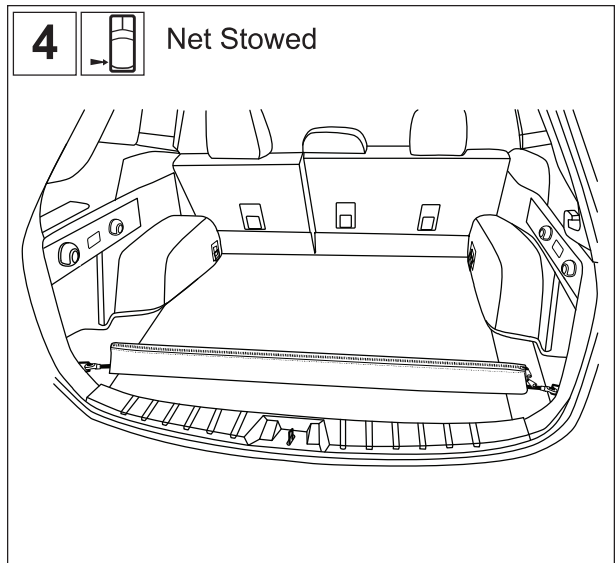
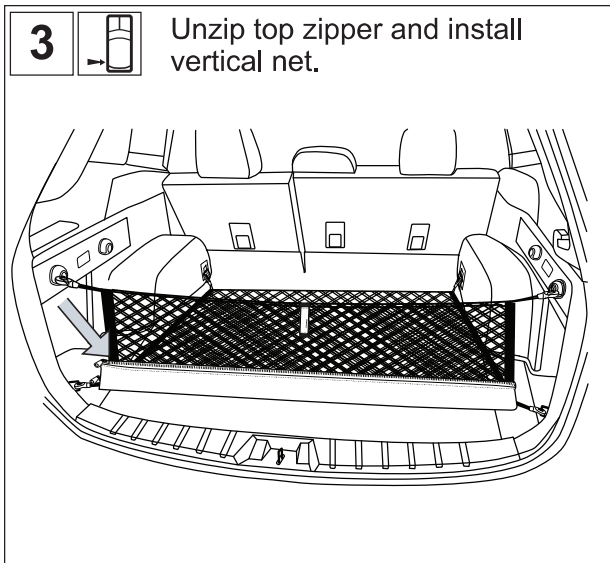
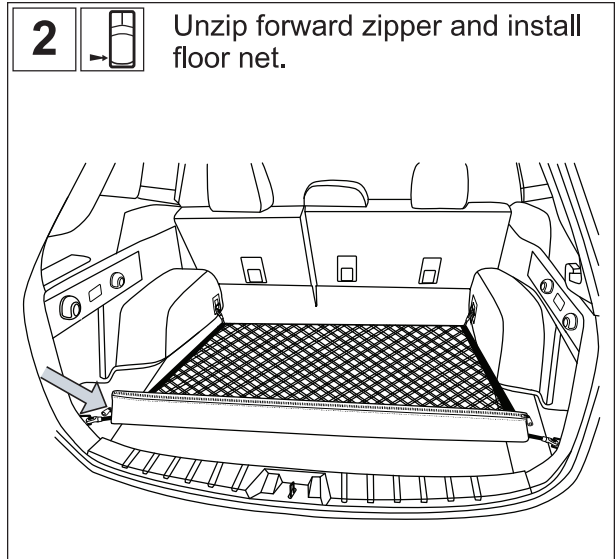
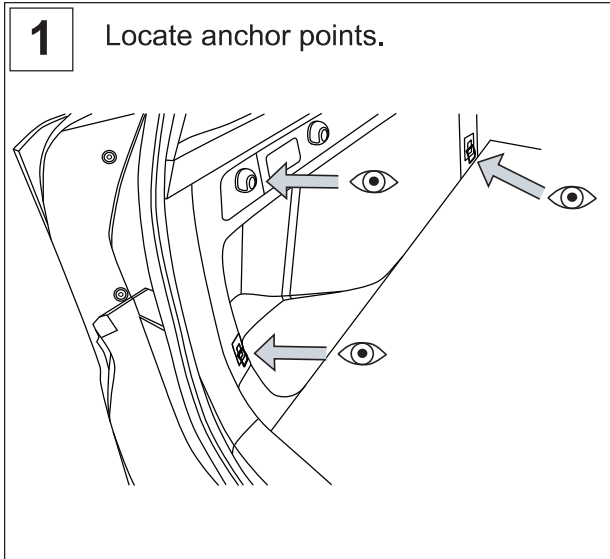

NOTE: Either net can be installed independently.

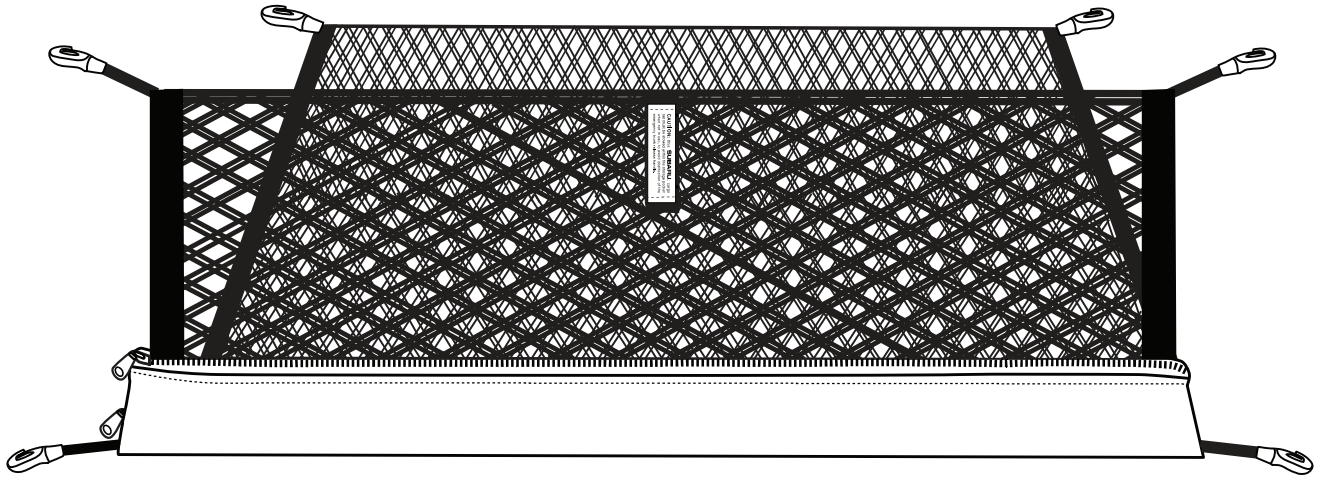
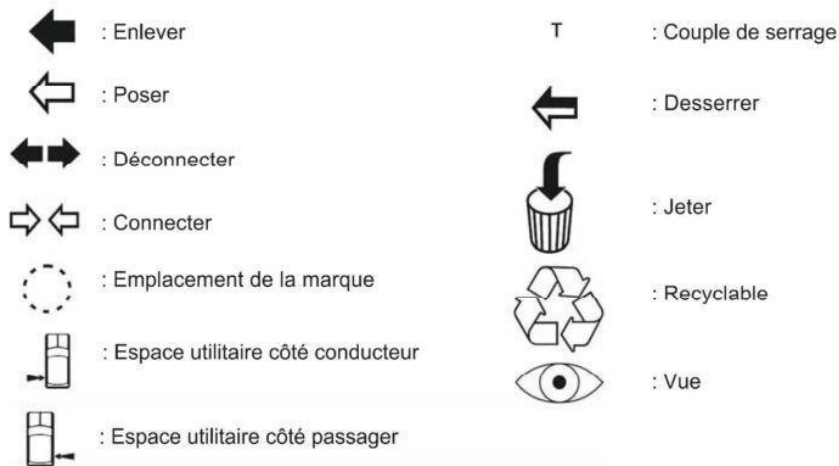
**A** **CONTENU DU KIT:****1X****OUTILS REQUIS: AUCUN****Signification des symboles:**

Remarque: Les opérations d'installation sont identiques pour l'autre côté du véhicule.

**1** Localiser les points d'ancrage.

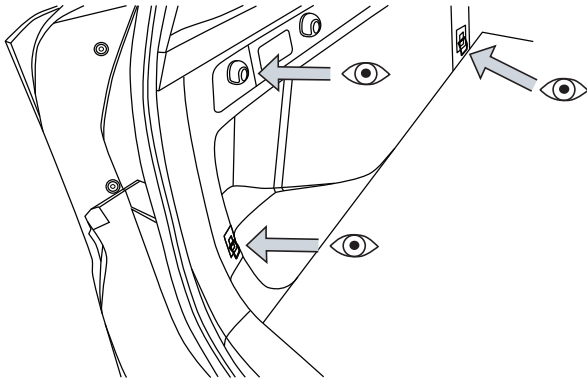

**2** Ouvrir la fermeture éclair avant et installer le filet de retenue du plancher.

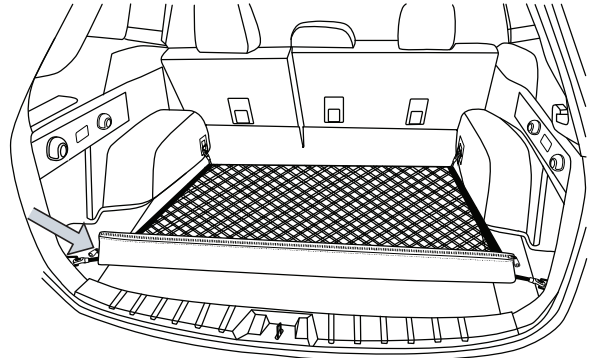

**3** Ouvrir la fermeture éclair supérieure et installer le filet de retenue vertical.

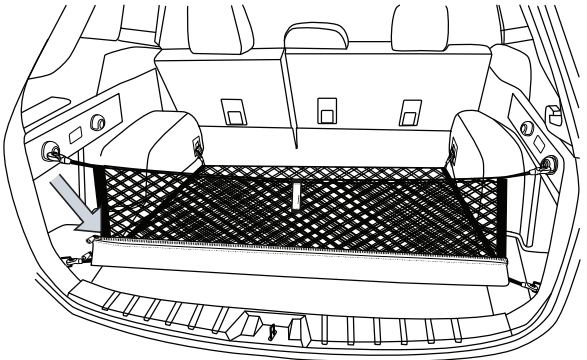

**4** Filet rangé.

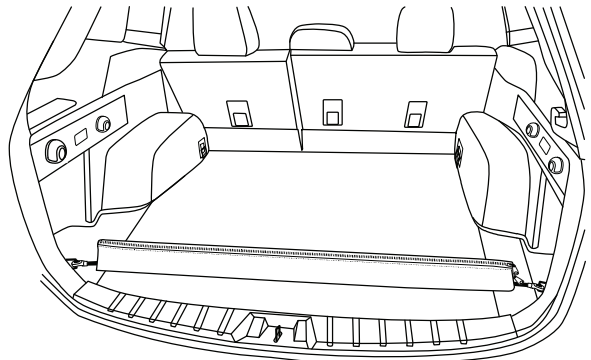

Remarque : Les filets peuvent être installés indépendamment l'un de l'autre.