

Convenience Net Package Installation

[Installation Instructions Part Number](#)

84583367

Kit Contents

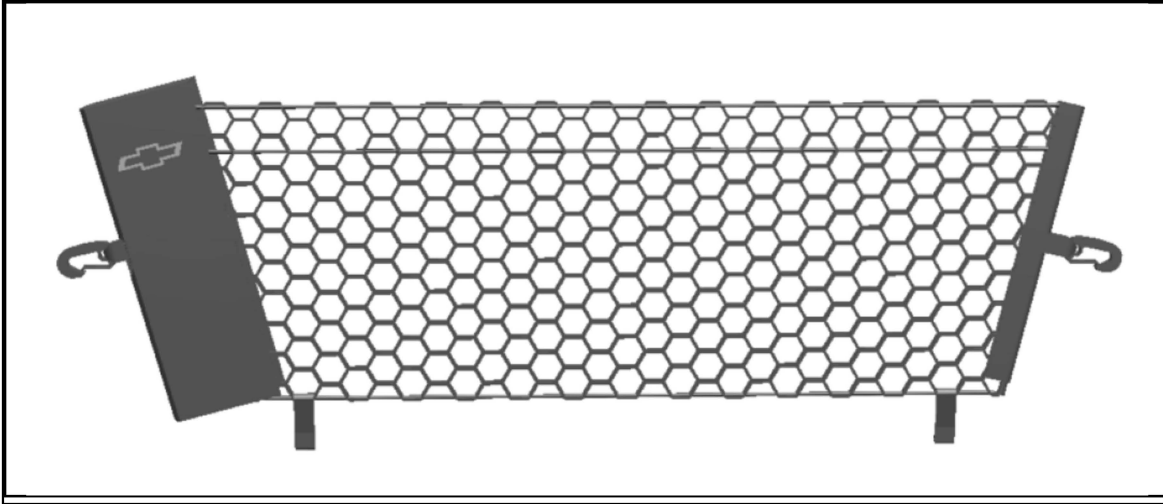

Procedure

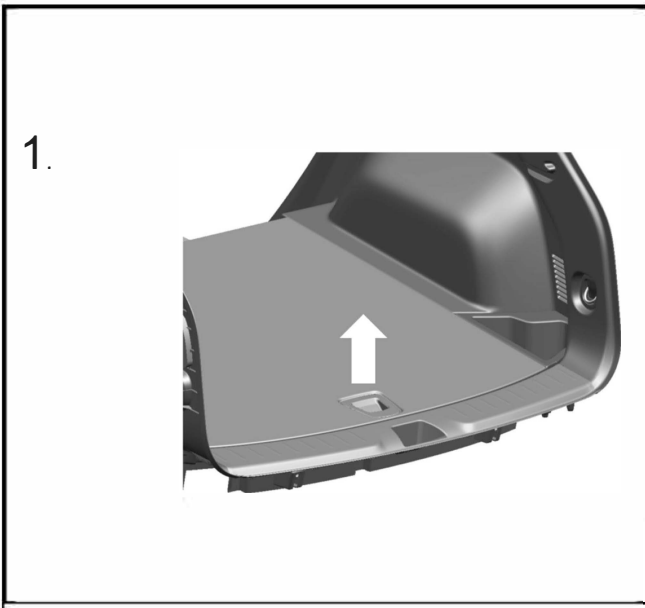

2.

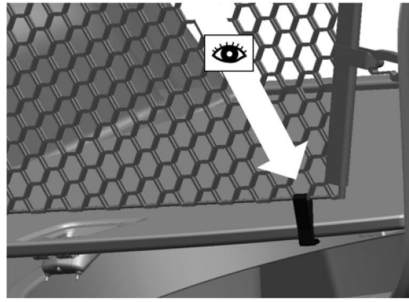
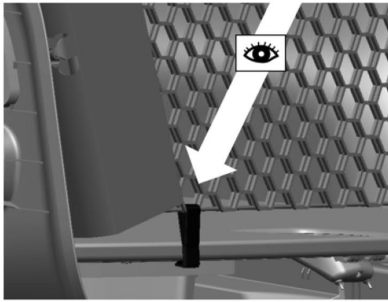

3.

①

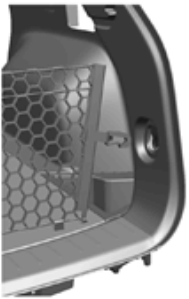

②

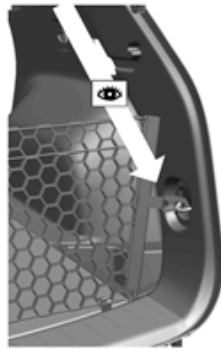

③



④

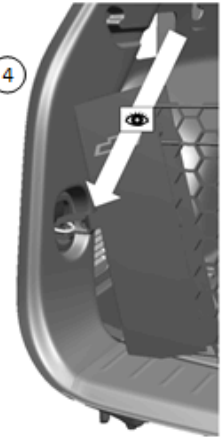

4.

